









# Selection table

	Identification	Characteristics	Working temperature	Details	Illustration	
Standard tensioner devices	<b>SE</b> Standard component	Steel parts ROSTA blue painted. Rubber quality Rubmix 10.	Housing and inner core made out of steel.	-40° to +80° C	Page 4.6	
	<b>SE-G</b> Oil resistant	Steel parts galvanized. Rubber quality Rubmix 20. Marked with yellow dot.		-30° to +90° C	Page 4.6	
	<b>SE-W</b> Heat resistant	Steel parts ROSTA blue painted. Rubber quality Rubmix 40. Marked with red dot. Tension force 40% less than SE.		+80° to +120° C max.	Page 4.6	
Additional tensioner devices	<b>SE-R</b> Reinforced lever arm	Arm and inner core especially welded for use on combustion engines and compressors. Steel parts ROSTA blue painted. Marked with white ring.	Housing and inner core made out of steel, inserts Rubmix 10.	-40° to +80° C	Page 4.6	
	<b>SE-I</b> Stainless steel	For the use in food- and pharmaceutic industries. Material: GX5CrNi19-10. Exception: SE-I 40 made out of X5CrNi18-10.			Page 4.6	
	<b>SE-F</b> Front mounting-device	For installations on blind-hole frames (fixation from the front only). Steel parts ROSTA blue painted. Hex socket screw quality 12.9.			Page 4.7	
	<b>SE-B</b> Boomerang®	For the tensioning of very long chain and belt drives (triple compensation). Steel parts ROSTA blue painted.			Page 4.7	
Accessories chain drives	<b>Sprocket wheel set N</b>	Allows accurate positioning of relevant chain track. Ball-bearings 2Z/C3, permanently lubricated.	-40° to +100° C	Page 4.8		
	<b>Sprocket wheel N</b>					
	<b>Chain rider set P</b>	For double sided use. Max. allowed chain speed 1.5 m/sec. Material: POM-H.	-40° to +100° C	Page 4.9		
<b>Chain rider P</b>						
Accessories belt drives	<b>Tensioning roller R</b>	Material: PA 6. Ball-bearings 2Z/C3, permanently lubricated.	-35° to +100° C	Page 4.10		

Further information to customized elements and installation examples as from page 4.12.

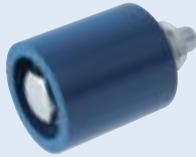

# General technology

The ROSTA tensioners should be installed on a stiff, even and clean machine part by means of the central bolt. The frictional connection on flange is usually fully sufficient for final positioning. The positioning notch on flange can be used to assure the tensioner additionally on uneven and dirty surfaces by setting a roller-pin.

## Tensioning force F

The tensioning force can be continuously adjusted. The max. pre-tensioning angle is +30° out of neutral position. Tensioning force table for types **SE / SE-G / SE-R / SE-F / SE-I** by using **hole-position "normal"** for sprocket-, rider- and roller fixation.

Size SE	Pre-tension $\leq 10^\circ$		Pre-tension $\leq 20^\circ$		Pre-tension $\leq 30^\circ$	
	F [N]	s [mm]	F [N]	s [mm]	F [N]	s [mm]
11	15	14	40	28	80	40
15	25	17	65	34	135	50
18	75	17	180	34	350	50
27	150	22	380	44	800	65
38	290	30	730	60	1500	87
45	500	39	1300	78	2600	112
50	750	43	2150	86	4200	125

**SE-I 40:** same tensioning force like SE 38.

**SE-W:** 40% lower tensioning force than standard versions (Rubmix 40 inserts).

**When fixing the sprockets, riders and rollers in arm-position "hard", tensioning force will increase on about 25%.**

## Mounting instructions

For further mounting instructions please consult the pages 4.9–4.11.

### Z-configuration of sprockets or riders

If there is the need to install sprockets, riders or rollers on the outer arm-side of the tensioner, then the distance "Z" should be as little as possible to avoid a misalignment in element parallelism. Furthermore the pre-tension force should not exceed 50% of the capacity = max. pre-tension angle of ~20°.



### Use of SE-B Boomerang® tensioners

In very long chain and belt drives it was recommendable to install on the slack-side several tensioners, in order to compensate occurring elongation. The "Boomerang" with its bent double-arm equipped with two chain sprockets or a combination of grooved pulley and flat-roller (belt-drives) **offers a triple-compensation of chain and belt elongations, due to S-shape contact-arc.**

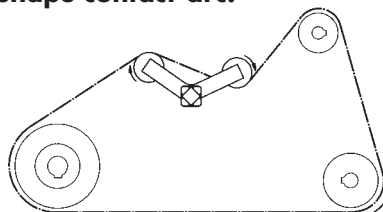

### Tensioner mounting

Tighten the flange screw slightly. Grip the housing with flat-wrench and set needful pre-tension by rotating the housing in the required direction. Tighten the central screw according the above mentioned tightening moment  $M_A$ .

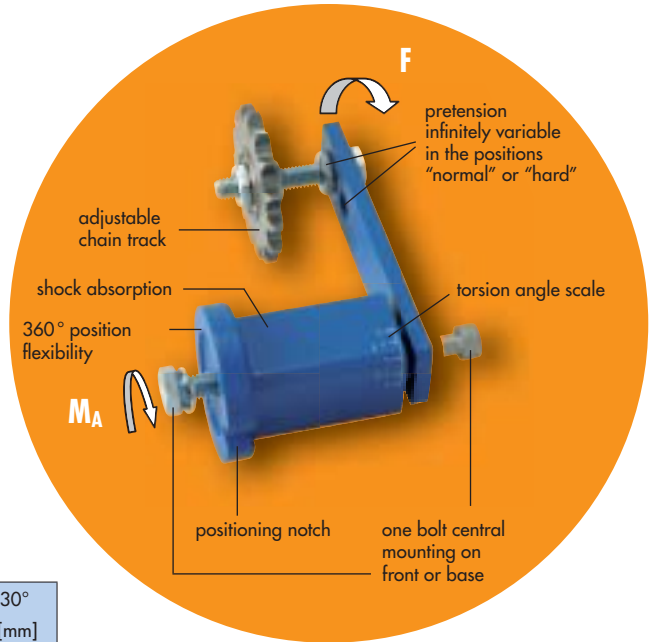
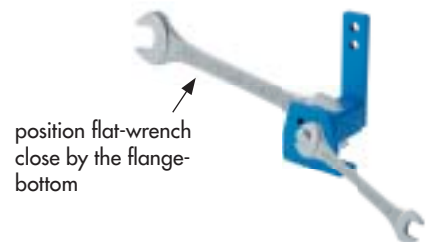

## Tightening moment $M_A$ for attachment screw

Table mentioning the tightening moment for the central screw (included in scope of delivery).

	Quality 8.8	Quality 12.9 only with SE-F
M6	10 Nm	17 Nm
M8	25 Nm	41 Nm
M10	49 Nm	83 Nm
M12	86 Nm	145 Nm
M16	210 Nm	355 Nm
M20	410 Nm	690 Nm
M24	750 Nm	

# Tensioner Devices

## Type SE-F

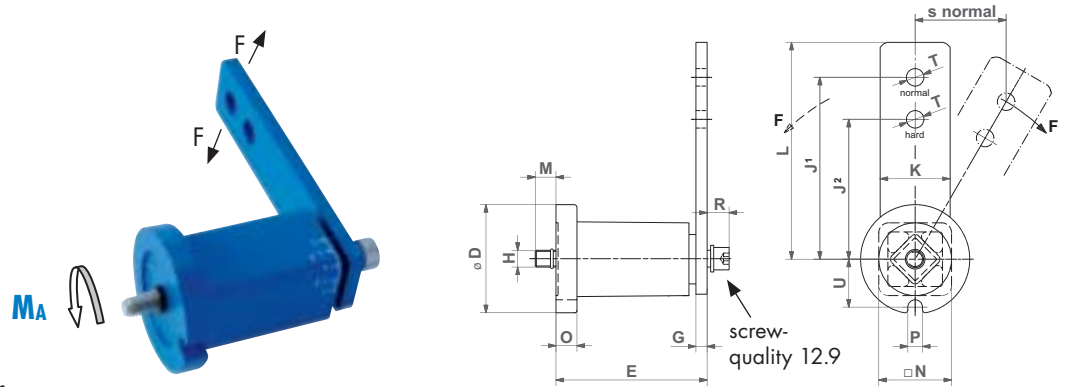

Tensioning element with front mounting

Type	Art. No.	D	E	G	H	J <sup>1</sup>	J <sup>2</sup>	K	L	M ca.	N	O	P	R	T	U	Weight [kg]
SE-F 15	06 061 002	45	64 <sup>+1</sup> <sub>-0.5</sub>	5	M6	100	80	25	112.5	12	30	8	8.5	10	10.5	20.8	0.4
SE-F 18	06 061 003	58	79 <sup>+1.5</sup> <sub>-0.5</sub>	7	M8	100	80	30	115	18	35	10.5	8.5	11	10.5	25.3	0.7
SE-F 27	06 061 004	78	108 <sup>+2</sup> <sub>-0.5</sub>	8	M10	130	100	50	155	17	52	15	10.5	15	12.5	34.3	1.9
SE-F 38	06 061 005	95	140 <sup>+2</sup> <sub>-0.5</sub>	10	M12	175	140	60	205	16	66	15	12.5	17	20.5	42.0	3.7
SE-F 45	06 061 006	115	200 <sup>+3</sup> <sub>-1</sub>	12	M16	225	180	70	260	32	80	18	12.5	24	20.5	52.0	6.9
SE-F 50	06 061 007	130	210 <sup>+3</sup> <sub>-1</sub>	20	M20	250	200	80	290	23	87	20	17	27	20.5	57.5	10.1

## Type SE-B Boomerang®

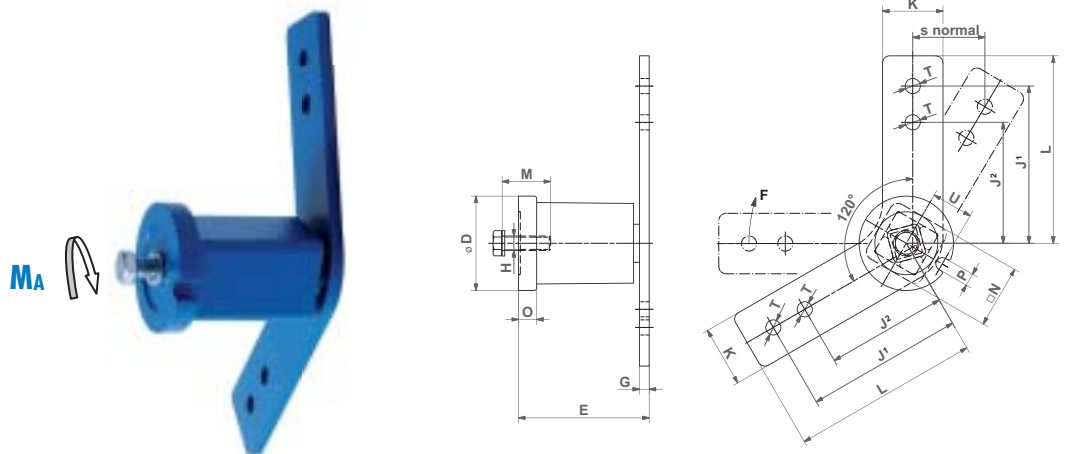

Type	Art. No.	D	E	G	H	J <sup>1</sup>	J <sup>2</sup>	K	L	M	N	O	P	T	U	Weight [kg]
SE-B 18	06 021 003	58	78 <sup>+1.5</sup> <sub>-0.5</sub>	6	M10	100	80	30	115	30	35	10.5	8.5	10.5	25.3	0.8
SE-B 27	06 021 004	78	108 <sup>+2</sup> <sub>-0.5</sub>	8	M12	130	100	50	155	40	52	15	10.5	12.5	34.3	2.1

Further product and performance datas on pages 4.4–4.5.