

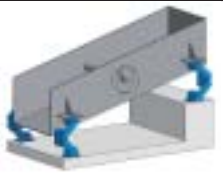











Selection table for free oscillating systems (with unbalanced excitation)

					
		One mass system circular motion screen	One mass system linear motion screen	Two mass system with counterframe	One mass system linear motion screen hanging
	AB Page 2.11	Oscillating Mounting – universal mounting. High vibration isolation and low residual force transmission. Natural frequencies approx. 2–3 Hz. 9 sizes from 50 N to 20'000 N per AB.			
	AB-HD Page 2.12	Oscillating Mounting for impact loading and high production peaks. (Heavy Duty) Natural frequencies approx. 2.5–3.5 Hz. 6 sizes from 500 N to 14'000 N per AB-HD.			
	AB-D Page 2.13		Oscillating Mounting in compact design. Optimal in two mass systems as counterframe mounting. Natural frequencies approx. 3–4.5 Hz. 7 sizes from 500 N to 16'000 N per AB-D.		
	ABI Page 2.14	Oscillating Mounting made from stainless steel for the food and pharmaceutical industry. High vibration isolation and low residual force transmission. Natural frequencies approx. 2–3 Hz. 6 sizes from 70 N to 6'800 N per ABI.			
	HS Page 2.15				Oscillating Mounting for hanging systems. Natural frequencies approx. 3–4 Hz. 5 sizes from 500 N to 14'000 N per HS.

Selection table for gyratory sifters

	AK Page 2.36	Universal Joint for the support or suspension of positive drive or freely oscillating gyratory sifting machines. 10 sizes up to 40'000 N per AK.	Gyratory sifter upright staying	Gyratory sifter hanging
	AV Page 2.38	Single Joint specially designed with large rubber volume for the suspension of gyratory sifting machines. Models with right-hand and left-hand threads. 5 sizes up to 16'000 N per AV.		

Technology

Design layout and evaluation

Subject	Symbol	• Example
Mass of the empty channel and drive	m_0	680 kg
Products on the channel		200 kg
of which approx. 50% coupling*		100 kg
Total vibrating mass*	m	780 kg
Mass distribution: feed end	% feed end	33%
discharge end	% discharge end	67%
Acceleration due to gravity	g	9.81 m/s ²
Load per corner feed end	$F_{\text{feed end}}$	1263 N
Load per corner discharge end	$F_{\text{discharge end}}$	2563 N
• Element choice in example		6 x AB 38
Working torque of both drives	AM	600 kgcm
Oscillating stroke empty channel	sw_0	8.8 mm
Oscillating stroke in operation	sw	7.7 mm
Motor revolutions	n_s	960 rpm
Centrifugal force of both drives	F_z	30'319 N
Oscillating machine factor	K	4.0
Machine acceleration	$a = K \cdot g$	4.0 g
• Natural frequency suspensions f_e		2.7 Hz
Degree of isolation	W	97%

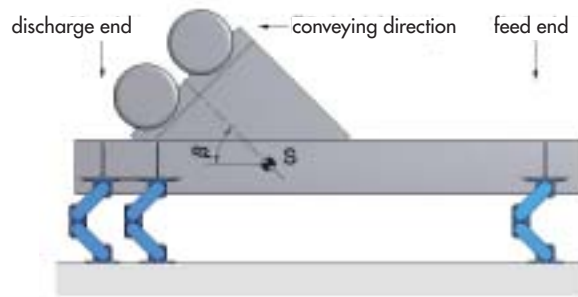

Calculation formulas

Loading per corner

$$F_{\text{feed-end}} = \frac{m \cdot g \cdot \% \text{ feed-end}}{2 \cdot 100} \quad F_{\text{discharge-end}} = \frac{m \cdot g \cdot \% \text{ discharge-end}}{2 \cdot 100}$$

Oscillating stroke (Amplitude peak to peak)

$$sw_0 = \frac{AM}{m_0} \cdot 10 \quad sw = \frac{AM}{m} \cdot 10$$

Centrifugal force

$$F_z = \frac{\left(\frac{2\pi}{60} \cdot n_s\right)^2 \cdot AM \cdot 10}{2 \cdot 1000} = \frac{n_s^2 \cdot AM}{18'240}$$

Oscillating machine factor

$$K = \frac{\left(\frac{2\pi}{60} \cdot n_s\right)^2 \cdot sw}{2 \cdot g \cdot 1000} = \frac{n_s^2 \cdot sw}{1'789'000}$$

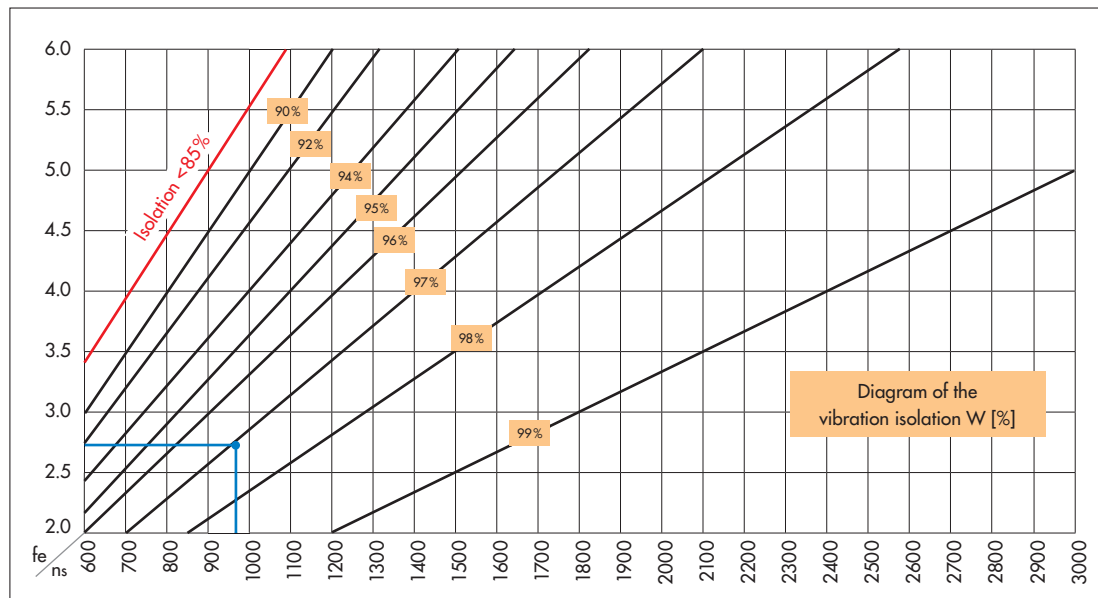

Vibration isolation

$$W = 100 - \frac{100}{\left(\frac{n_s}{60 \cdot f_e}\right)^2 - 1}$$

• Example:

The proportion of the relationship between exciter frequency 16 Hz (960 rpm) and mount frequency 2.7 Hz is offering a degree of isolation of 97%.

* The following has to be observed for the determination of the coupling effect and material flow:

- High coupling or sticking of humid bulk material
- Channel running full
- Fully stacked screen deck with humid material
- Weight distribution with and without conveyed material
- Centrifugal force does not run through the center of gravity (channel full or empty)
- Sudden impact loading occurs
- Subsequent additions to the screen structure (e.g. additional screening deck)



Technology

Determination of the average material conveying speed v_m

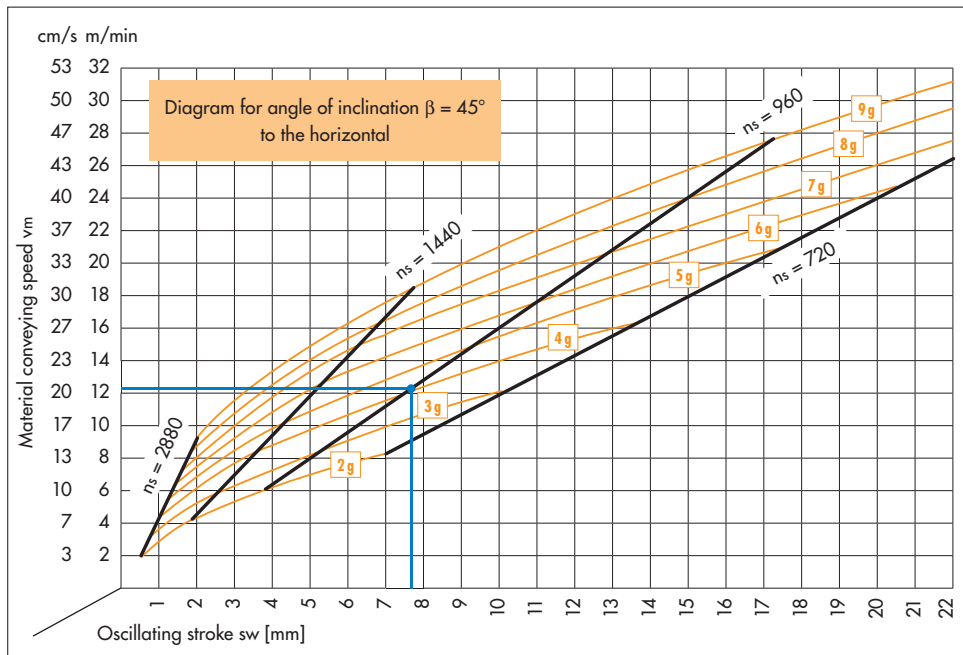

Main influencing factors:

- Conveying ability of the material
- Height of the bulk goods
- Screen box inclination
- Position of unbalanced motors
- Position of the center of gravity

The material speed on circular motion screens does vary, due to differing screen-box inclination angles.

• Example:

The horizontal line out of the intercept point of stroke (7.7 mm) and motor revolutions (960 rpm) is indicating an average theoretical speed of 12.3 m/min or 20.5 cm/sec.

Resonance amplification and continuous running

At the screen start-up and run-out the suspension elements are passing through the resonance frequency. By the resulting amplitude superelevation the four rubber suspensions in the AB mountings do generate a high level of damping which is absorbing the remaining energy after only a few strokes. The screen box stops its motion within seconds.

Laboratory measurements of a typical development of the residual forces on a ROSTA screen suspension:

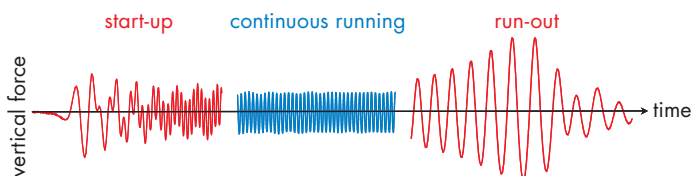

Alignment of the elements

If the suspensions for linear motion screens are arranged as shown on page 2.7, a harmonic, noiseless oscillation of the screen will result. The rocker arm fixed to the screen carries out the greater part of the oscillations. The rocker arm fixed to the substructure remains virtually stationary and ensures a low natural frequency, and thereby also a good vibration isolation. The mounting axis has to be arranged to be at right angles (90°) to the conveying axis, with maximum tolerance of $\pm 1^\circ$.

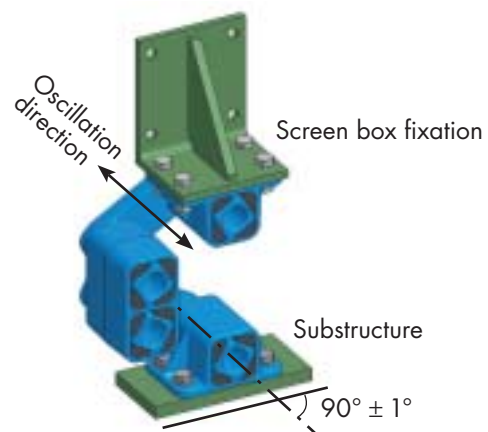

Compression load AB

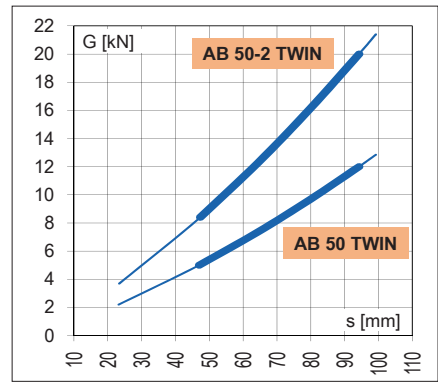
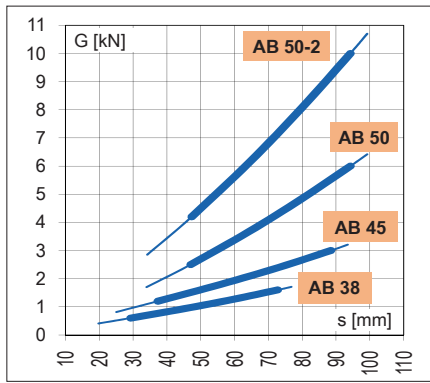
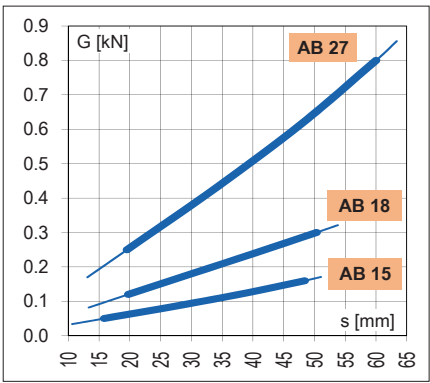

Deflection curves and cold flow behaviours

Diagrams showing the vertical deflection s (in mm) by compression or tensile load G (in kN). The shown values comprehend the **initial cold flow settling** after one day of operation. The final element deflection after the full cold flow compensation (after approx. 1 year) is usually factor $\times 1,09$ higher (depending on specific application, climate etc.).

Final element deflection
 $= s \times 1,09$

The deflection values are based on our catalogue specifications and should be understood as approximate values. Please consult also our tolerance specifications in chapter "Technology" in the general catalogue.

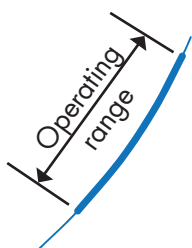

Compression load AB-HD

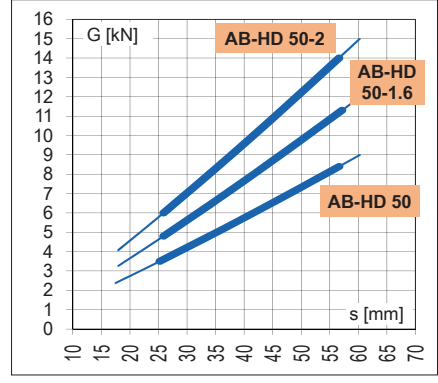
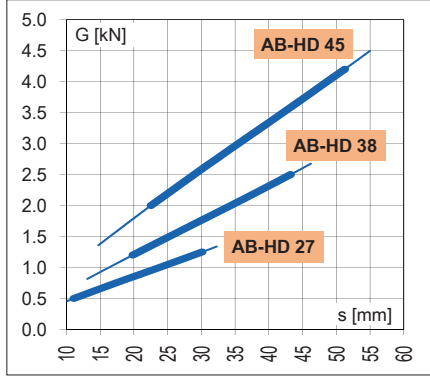

Compression load AB-D

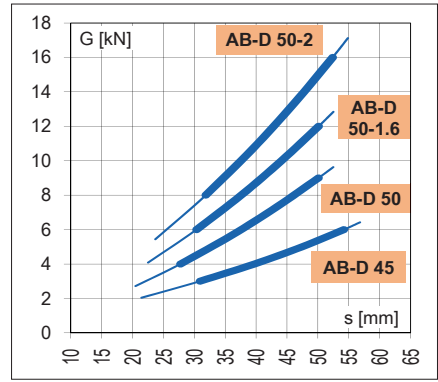
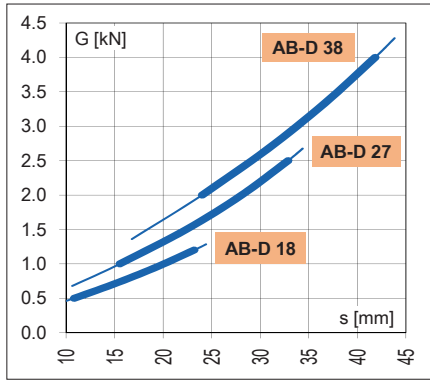

Compression load ABI

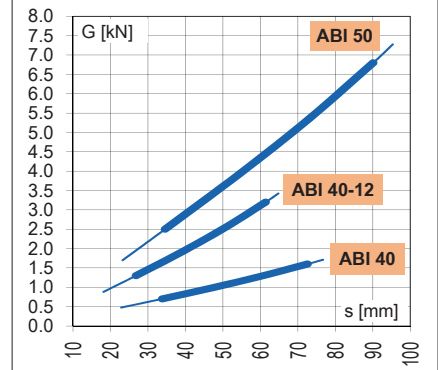
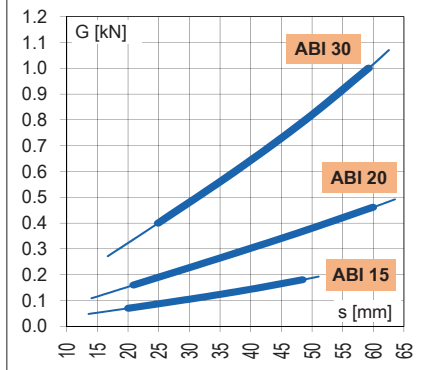

Tensile load HS

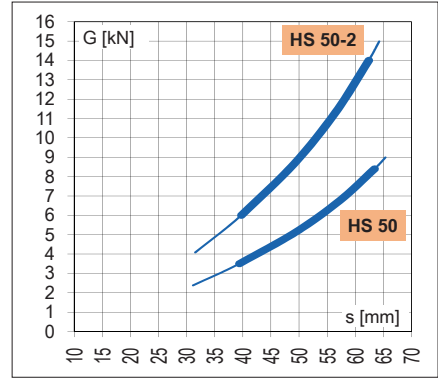
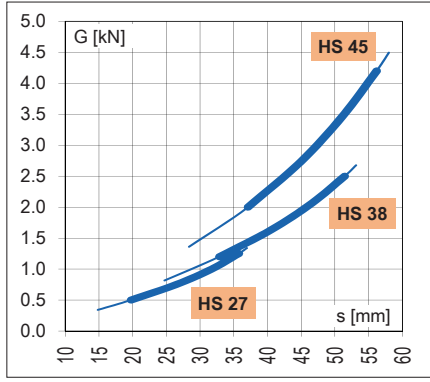

Oscillating Mountings

Type AB-D

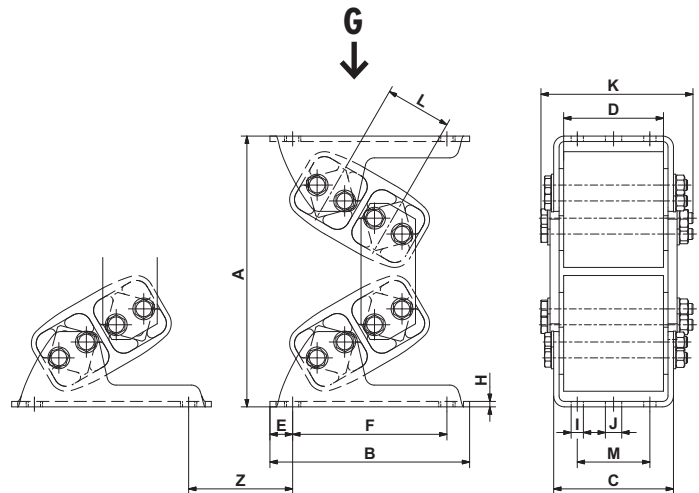

Art. No.	Type	Load capacity Gmin. – Gmax. [N]	A un- loaded	A* max. load	B	C	D	E	F	H	I	J	K	L	M	Weight [kg]
07 281 000	AB-D 18	500 – 1'200	137	112	115	61	50	12.5	90	3	9	9	74	31	30	1.3
07 281 001	AB-D 27	1'000 – 2'500	184	148	150	93	80	15	120	4	9	11	116	44	50	2.9
07 281 002	AB-D 38	2'000 – 4'000	244	199	185	118	100	17.5	150	5	11	13.5	147	60	70	7.5
07 281 003	AB-D 45	3'000 – 6'000	298	240	220	132	110	25	170	6	13.5	18	168	73	80	11.5
07 281 004	AB-D 50	4'000 – 9'000	329	272	235	142	120	25	185	6	13.5	18	166	78	90	17.9
07 281 005	AB-D 50-1.6	6'000 – 12'000	329	272	235	186	160	25	185	8	13.5	18	214	78	90	24.5
07 281 006	AB-D 50-2	8'000 – 16'000	329	272	235	226	200	25	185	8	13.5	18	260	78	90	29.0

Art. No.	Type	Natural frequency Gmin.–Gmax. [Hz]	Z**	Dynamic spring value			Capacity limits by different rpm						Light metal profile	Steel plate	Nodular cast iron	ROSTA blue painted
				cd vertical [N/mm]	cd at sw [mm]	cd horizontal [N/mm]	720 min ⁻¹ sw max. [mm]	K max. [-]	960 min ⁻¹ sw max. [mm]	K max. [-]	1440 min ⁻¹ sw max. [mm]	K max. [-]				
07 281 000	AB-D 18	6.1–4.4	30	100	4	20	5	1.4	5	2.6	4	4.6	x	x		x
07 281 001	AB-D 27	5.4–3.9	35	160	4	35	7	2.0	6	3.1	5	5.8	x	x		partial
07 281 002	AB-D 38	4.3–3.4	40	185	6	40	9	2.6	8	4.1	6	7.0	x	x		partial
07 281 003	AB-D 45	3.7–3.1	55	230	8	70	11	3.2	9	4.6	7	8.1	x	x		partial
07 281 004	AB-D 50	3.7–2.9	55	310	8	120	12	3.5	10	5.2	8	9.3	x	x	x	x
07 281 005	AB-D 50-1.6	3.6–2.9	55	430	8	160	12	3.5	10	5.2	8	9.3	x	x	x	x
07 281 006	AB-D 50-2	3.5–2.8	55	540	8	198	12	3.5	10	5.2	8	9.3	x	x	x	x
Values in nominal load range at 960 rpm							Acceleration > 9.3 g is not recommended					Material structure (zinc-plated couplings)				

These types can be combined with one another (identical heights and operation behaviour)

* compression load Gmax. and final cold flow compensation (after approx. 1 year).

** separate assembly instructions are available, please ask for details.