

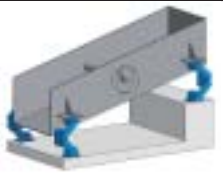











# Selection table for free oscillating systems (with unbalanced excitation)

					
		One mass system circular motion screen	One mass system linear motion screen	Two mass system with counterframe	One mass system linear motion screen hanging
	<b>AB</b> Page 2.11	<b>Oscillating Mounting</b> – universal mounting. High vibration isolation and low residual force transmission. Natural frequencies approx. 2–3 Hz. 9 sizes from 50 N to 20'000 N per AB.			
	<b>AB-HD</b> Page 2.12	<b>Oscillating Mounting</b> for impact loading and high production peaks. (Heavy Duty) Natural frequencies approx. 2.5–3.5 Hz. 6 sizes from 500 N to 14'000 N per AB-HD.			
	<b>AB-D</b> Page 2.13		<b>Oscillating Mounting</b> in compact design. Optimal in two mass systems as counterframe mounting. Natural frequencies approx. 3–4.5 Hz. 7 sizes from 500 N to 16'000 N per AB-D.		
	<b>ABI</b> Page 2.14	<b>Oscillating Mounting</b> made from stainless steel for the food and pharmaceutical industry. High vibration isolation and low residual force transmission. Natural frequencies approx. 2–3 Hz. 6 sizes from 70 N to 6'800 N per ABI.			
	<b>HS</b> Page 2.15				<b>Oscillating Mounting</b> for hanging systems. Natural frequencies approx. 3–4 Hz. 5 sizes from 500 N to 14'000 N per HS.

# Selection table for gyratory sifters

	<b>AK</b> Page 2.36	<b>Universal Joint</b> for the support or suspension of positive drive or freely oscillating gyratory sifting machines. 10 sizes up to 40'000 N per AK.	<b>Gyratory sifter upright staying</b>	<b>Gyratory sifter hanging</b>
	<b>AV</b> Page 2.38	<b>Single Joint</b> specially designed with large rubber volume for the suspension of gyratory sifting machines. Models with right-hand and left-hand threads. 5 sizes up to 16'000 N per AV.		

# Technology

## Design layout and evaluation

Subject	Symbol	• Example
Mass of the empty channel and drive	$m_0$	680 kg
Products on the channel		200 kg
of which approx. 50% coupling*		100 kg
Total vibrating mass*	$m$	780 kg
Mass distribution: feed end	% feed end	33%
discharge end	% discharge end	67%
Acceleration due to gravity	$g$	9.81 m/s <sup>2</sup>
Load per corner feed end	$F_{\text{feed end}}$	1263 N
Load per corner discharge end	$F_{\text{discharge end}}$	2563 N
• Element choice in example		<b>6 x AB 38</b>
Working torque of both drives	AM	600 kgcm
Oscillating stroke empty channel	$sw_0$	8.8 mm
Oscillating stroke in operation	$sw$	7.7 mm
Motor revolutions	$n_s$	960 rpm
Centrifugal force of both drives	$F_z$	30'319 N
Oscillating machine factor	K	4.0
Machine acceleration	$a = K \cdot g$	4.0 g
• Natural frequency suspensions $f_e$		<b>2.7 Hz</b>
Degree of isolation	W	97%

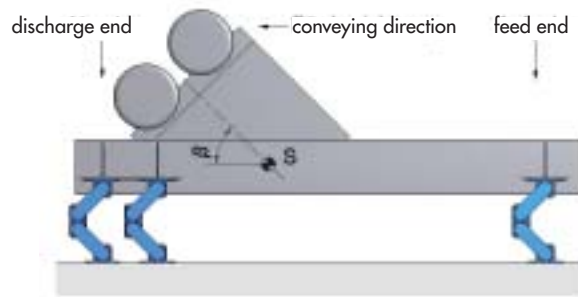

### Calculation formulas

#### Loading per corner

$$F_{\text{feed-end}} = \frac{m \cdot g \cdot \% \text{ feed-end}}{2 \cdot 100} \quad F_{\text{discharge-end}} = \frac{m \cdot g \cdot \% \text{ discharge-end}}{2 \cdot 100}$$

#### Oscillating stroke (Amplitude peak to peak)

$$sw_0 = \frac{AM}{m_0} \cdot 10 \quad sw = \frac{AM}{m} \cdot 10$$

#### Centrifugal force

$$F_z = \frac{\left(\frac{2\pi}{60} \cdot n_s\right)^2 \cdot AM \cdot 10}{2 \cdot 1000} = \frac{n_s^2 \cdot AM}{18'240}$$

#### Oscillating machine factor

$$K = \frac{\left(\frac{2\pi}{60} \cdot n_s\right)^2 \cdot sw}{2 \cdot g \cdot 1000} = \frac{n_s^2 \cdot sw}{1'789'000}$$

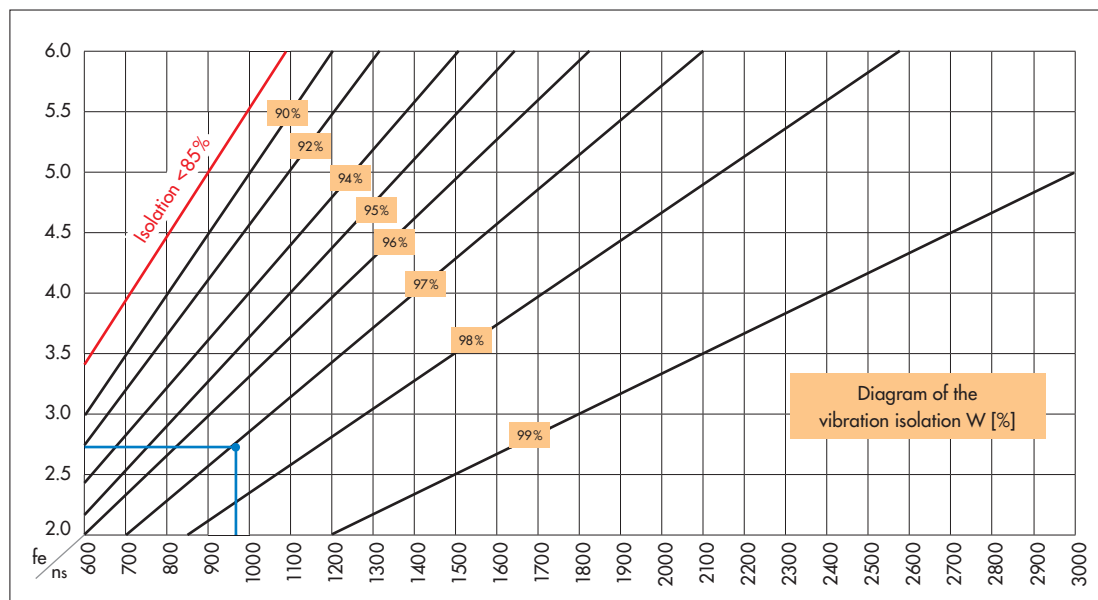

### Vibration isolation

$$W = 100 - \frac{100}{\left(\frac{n_s}{60 \cdot f_e}\right)^2 - 1}$$

#### • Example:

The proportion of the relationship between exciter frequency 16 Hz (960 rpm) and mount frequency 2.7 Hz is offering a degree of isolation of 97%.

\* The following has to be observed for the determination of the coupling effect and material flow:

- High coupling or sticking of humid bulk material
- Channel running full
- Fully stacked screen deck with humid material
- Weight distribution with and without conveyed material
- Centrifugal force does not run through the center of gravity (channel full or empty)
- Sudden impact loading occurs
- Subsequent additions to the screen structure (e.g. additional screening deck)



# Technology

## Determination of the average material conveying speed $v_m$

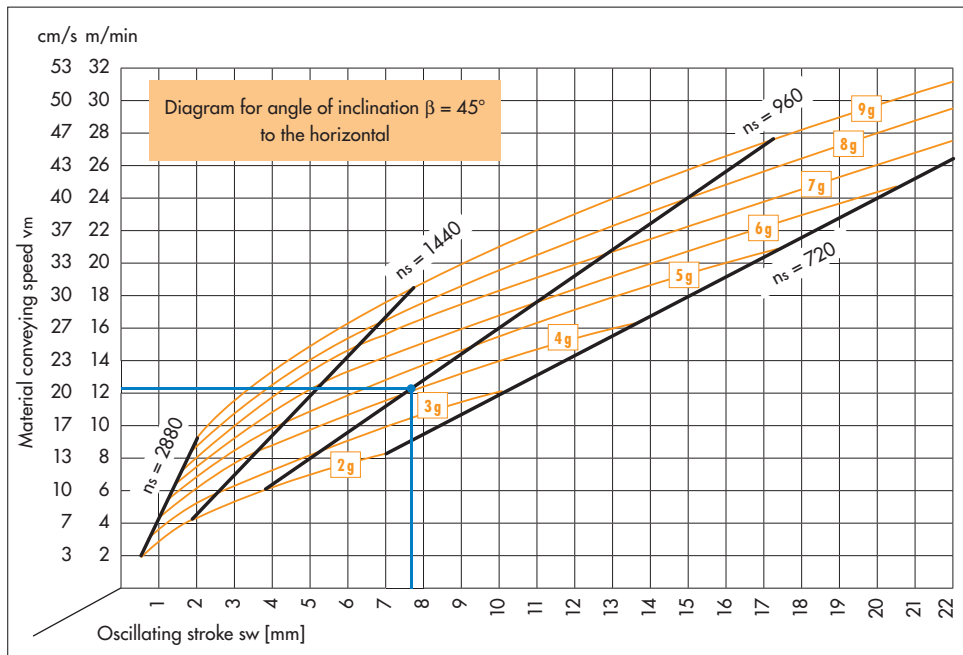

### Main influencing factors:

- Conveying ability of the material
- Height of the bulk goods
- Screen box inclination
- Position of unbalanced motors
- Position of the center of gravity

The material speed on circular motion screens does vary, due to differing screen-box inclination angles.

### • Example:

The horizontal line out of the intercept point of stroke (7.7 mm) and motor revolutions (960 rpm) is indicating an average theoretical speed of 12.3 m/min or 20.5 cm/sec.

## Resonance amplification and continuous running

At the screen start-up and run-out the suspension elements are passing through the resonance frequency. By the resulting amplitude superelevation the four rubber suspensions in the AB mountings do generate a high level of damping which is absorbing the remaining energy after only a few strokes. The screen box stops its motion within seconds.

Laboratory measurements of a typical development of the residual forces on a ROSTA screen suspension:

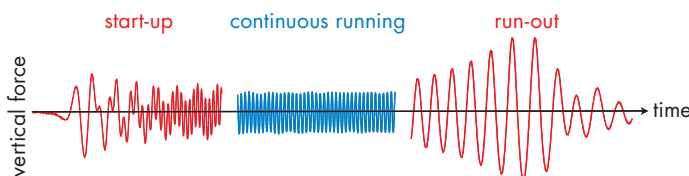

## Alignment of the elements

If the suspensions for linear motion screens are arranged as shown on page 2.7, a harmonic, noiseless oscillation of the screen will result. The rocker arm fixed to the screen carries out the greater part of the oscillations. The rocker arm fixed to the substructure remains virtually stationary and ensures a low natural frequency, and thereby also a good vibration isolation. The mounting axis has to be arranged to be at right angles ( $90^\circ$ ) to the conveying axis, with maximum tolerance of  $\pm 1^\circ$ .

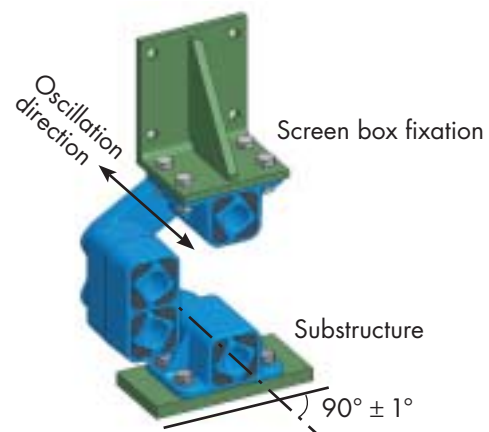

Compression load AB

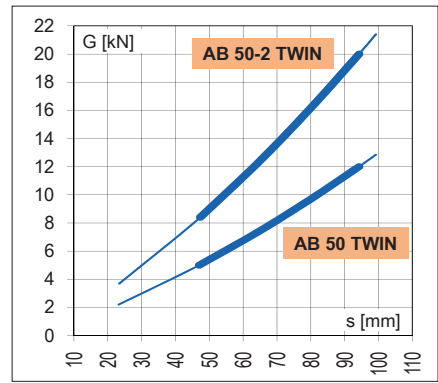
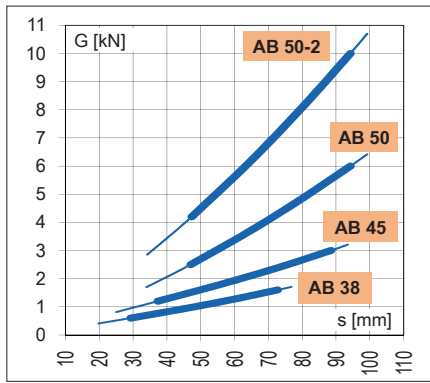
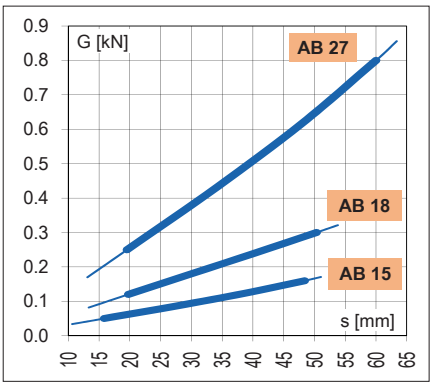

Deflection curves and cold flow behaviours

Diagrams showing the vertical deflection  $s$  (in mm) by compression or tensile load  $G$  (in kN). The shown values comprehend the **initial cold flow settling** after one day of operation. The final element deflection after the full cold flow compensation (after approx. 1 year) is usually factor  $\times 1,09$  higher (depending on specific application, climate etc.).

**Final element deflection**  
 $= s \times 1,09$

The deflection values are based on our catalogue specifications and should be understood as approximate values. Please consult also our tolerance specifications in chapter "Technology" in the general catalogue.

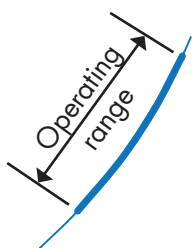

Compression load AB-HD

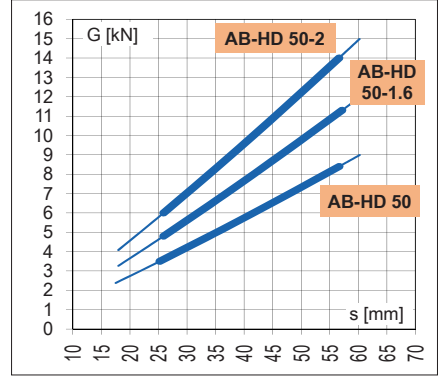
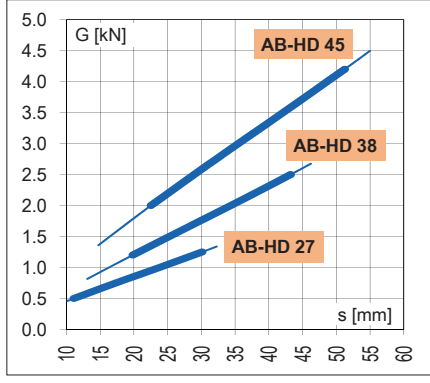

Compression load AB-D

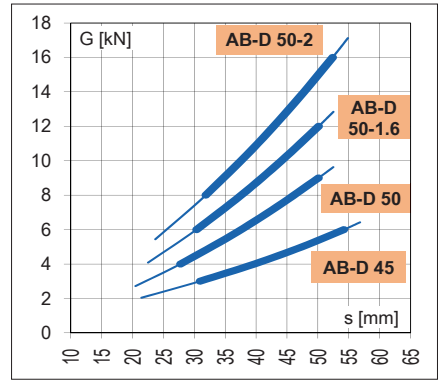
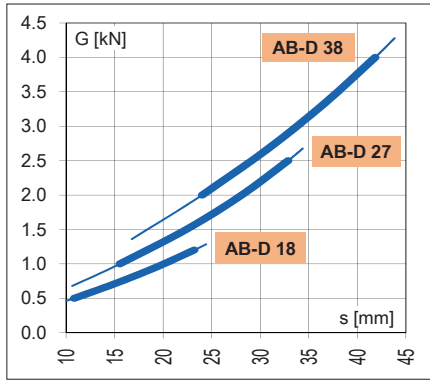

Compression load ABI

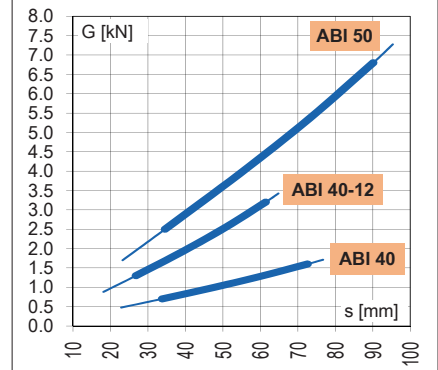
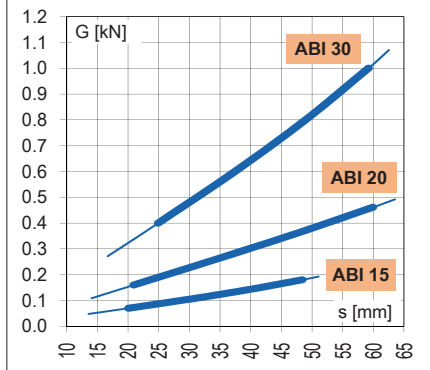

Tensile load HS

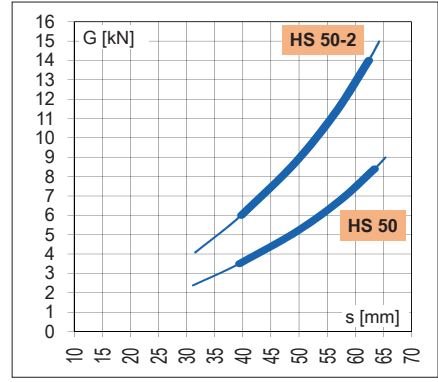
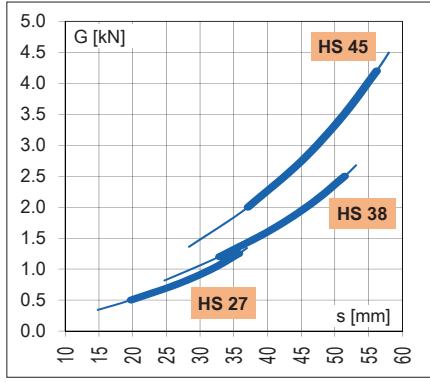



# Oscillating Mountings

## Type AB-HD

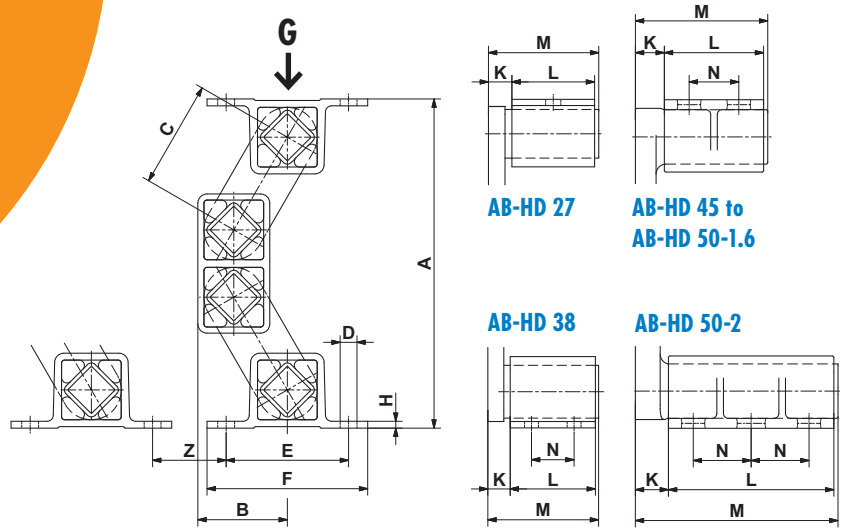

Art. No.	Type	Load capacity Gmin. – Gmax. [N]	A un- loaded	A* max. load	B un- loaded	B* max. load	C	D	E	F	H	K	L	M	N	Weight [kg]
07 051 070	<b>AB-HD 27</b>	500 – 1'250	215	182	59	78	70	∅11	80	105	4.5	17	60	80	-	1.6
07 051 071	<b>AB-HD 38</b>	1'200 – 2'500	293	246	79	106	95	∅13	100	125	6	21	80	104	40	4.9
07 051 072	<b>AB-HD 45</b>	2'000 – 4'200	346	290	98	130	110	13x20	115	145	8	28	100	132	65	11.3
07 051 062	<b>AB-HD 50</b>	3'500 – 8'400	376	313	105	141	120	17x27	130	170	12	40	120	165	60	22.7
07 051 063	<b>AB-HD 50-1.6</b>	4'800 – 11'300	376	313	105	141	120	17x27	130	170	12	40	160	205	70	27.1
07 051 060	<b>AB-HD 50-2</b>	6'000 – 14'000	376	313	105	141	120	17x27	130	170	12	45	200	250	70	35.5

Art. No.	Type	Natural frequency Gmin. – Gmax. [Hz]	Z**	Dynamic spring value		Capacity limits by different rpm						Light metal profile	Steel welded construction	Nodular cast iron	ROSTA blue painted
				cd vertical [N/mm]	cd horizontal [N/mm]	720 min <sup>-1</sup> sw max. [mm] K max. [-]	960 min <sup>-1</sup> sw max. [mm] K max. [-]	1440 min <sup>-1</sup> sw max. [mm] K max. [-]							
07 051 070	<b>AB-HD 27</b>	4.8 – 3.1	70	70	33	12	3.5	10	5.2	8	9.3	x	x		x
07 051 071	<b>AB-HD 38</b>	3.6 – 2.7	90	100	48	15	4.3	13	6.7	8	9.3	x	x		x
07 051 072	<b>AB-HD 45</b>	3.3 – 2.5	100	150	72	17	4.9	14	7.2	8	9.3	x	x	x	x
07 051 062	<b>AB-HD 50</b>	3.2 – 2.4	120	270	130	18	5.2	15	7.7	8	9.3			x	x
07 051 063	<b>AB-HD 50-1.6</b>	3.2 – 2.4	120	360	172	18	5.2	15	7.7	8	9.3		x	x	x
07 051 060	<b>AB-HD 50-2</b>	3.2 – 2.4	120	450	215	18	5.2	15	7.7	8	9.3			x	x
				Values in nominal load range at 960 rpm and sw of 8 mm		Acceleration > 9.3 g is not recommended						Material structure			

Please find elements for higher load capacities on page 2.17.

These types can be combined with one another (identical heights and operation behaviour)

\* compression load G<sub>max.</sub> and final cold flow compensation (after approx. 1 year).

\*\* separate assembly instructions are available, please ask for details.

