

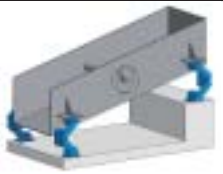











Selection table for free oscillating systems (with unbalanced excitation)

					
		One mass system circular motion screen	One mass system linear motion screen	Two mass system with counterframe	One mass system linear motion screen hanging
	AB Page 2.11	Oscillating Mounting – universal mounting. High vibration isolation and low residual force transmission. Natural frequencies approx. 2–3 Hz. 9 sizes from 50 N to 20'000 N per AB.			
	AB-HD Page 2.12	Oscillating Mounting for impact loading and high production peaks. (Heavy Duty) Natural frequencies approx. 2.5–3.5 Hz. 6 sizes from 500 N to 14'000 N per AB-HD.			
	AB-D Page 2.13		Oscillating Mounting in compact design. Optimal in two mass systems as counterframe mounting. Natural frequencies approx. 3–4.5 Hz. 7 sizes from 500 N to 16'000 N per AB-D.		
	ABI Page 2.14	Oscillating Mounting made from stainless steel for the food and pharmaceutical industry. High vibration isolation and low residual force transmission. Natural frequencies approx. 2–3 Hz. 6 sizes from 70 N to 6'800 N per ABI.			
	HS Page 2.15				Oscillating Mounting for hanging systems. Natural frequencies approx. 3–4 Hz. 5 sizes from 500 N to 14'000 N per HS.

Selection table for gyratory sifters

	AK Page 2.36	Universal Joint for the support or suspension of positive drive or freely oscillating gyratory sifting machines. 10 sizes up to 40'000 N per AK.	Gyratory sifter upright staying	Gyratory sifter hanging
	AV Page 2.38	Single Joint specially designed with large rubber volume for the suspension of gyratory sifting machines. Models with right-hand and left-hand threads. 5 sizes up to 16'000 N per AV.		



Oscillating Mountings for hanging Gyratory Sifters

Type AV

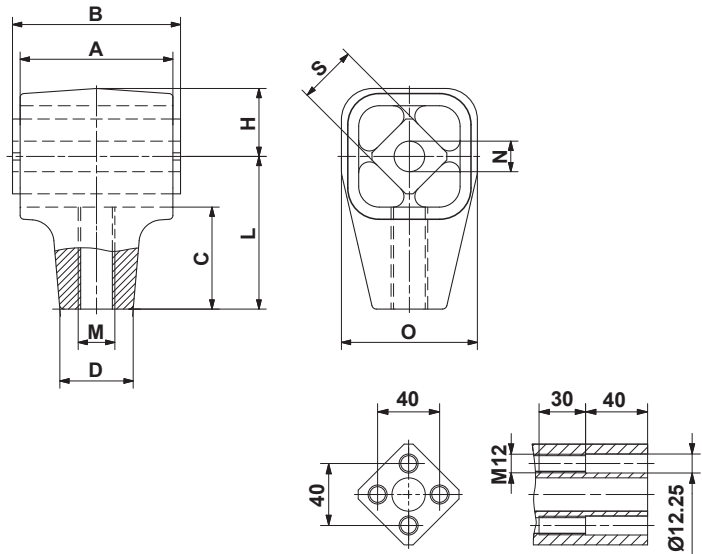

Inner square AV 50 and AV 50L

Art. No.	Type	G [N] per suspension	A	B ^{±0.2}	C	□D	H	L	M	∅ N	O	□S
07 261 001	AV 18	600 – 1'600	60	65	40.5	28	27	60	M16	13 _{-0.2}	54	18
07 271 001	AV 18L								M16-LH			
07 261 002	AV 27	1'300 – 3'000	80	90	53	42	37	80	M20	16 _{+0.5} -0.3	74	27
07 271 002	AV 27L								M20-LH			
07 261 003	AV 38	2'600 – 5'000	100	110	67	48	44	100	M24	20 _{+0.5} -0.2	89	38
07 271 003	AV 38L								M24-LH			
07 261 004	AV 40	4'500 – 7'500	120	130	69.5	60	47	105	M36	20 _{+0.5} -0.2	93	40
07 271 004	AV 40L								M36-LH			
07 261 005	AV 50	6'000 – 16'000	200	210	85	80	59	130	M42	-	116	50
07 271 005	AV 50L								M42-LH			

G = max. load in N per suspension
 Elements for higher load on request

Art. No.	Type	Weight [kg]	Material structure			Bolting on inner square
			Inner square	Housing	Prot.	
07 261 001	AV 18	0.4	Light metal profile	Light metal casting	ROSTA blue painted	End-to-end screw or threaded bar quality 8.8.
07 271 001	AV 18L					
07 261 002	AV 27	1.0	Light metal profile	Light metal casting	ROSTA blue painted	
07 271 002	AV 27L					
07 261 003	AV 38	1.7	Steel	Nodular cast iron	ROSTA blue painted	
07 271 003	AV 38L					
07 261 004	AV 40	4.5	Steel	Nodular cast iron	ROSTA blue painted	
07 271 004	AV 40L					
07 261 005	AV 50	12.3	Light metal profile	Nodular cast iron	ROSTA blue painted	M12 shoulder studs quality 8.8.
07 271 005	AV 50L					

General advises

The operating parameters shall not exceed the guidelines of the "frequency spectrum", see Technology part in the ROSTA general catalogue.

The threaded connection rod has to be provided by the customer.

Calculation Example

Description	Symbol	Technical data	Calculation formula
Total oscillating mass (material included)	m	800 kg	Angle of oscillation
Eccentric radius ②	R	20 mm	
Length of suspension rod	X	600 mm	$\beta = \arctan\left(\frac{R}{X}\right)$
Angle of oscillation (out of R and X), shall not exceed $\pm 2^\circ$ ②	$\beta \pm$	1.9°	Load per suspension rod
Revolutions	n_s	230 min^{-1}	
Quantity of suspension rods	z	4 pcs.	
Load per suspension rod	G	1962 N	
Max. load capacity per rod with AV 27 mountings	G_{max}	3000 N	
			$G = \frac{m \cdot g}{z}$

Element Selection:

4 pcs. AV 27 and 4 pcs. AV 27 L (left-hand threaded), the two AV elements per suspension rod have to be installed crosswise (90° offset).

Installation guidelines for AV mountings

- ① With the right-hand and left-hand threaded connection in the AV housing the length X of the suspension rod can easily be adjusted, this length has to be identical for all four suspension rods. **The indicated angular oscillating limitations have to be respected!**
- ② Only the **crosswise** (90° offset) installation of the two AV elements per suspension rod is guaranteeing for a harmonic and circular motion of the screen-box.
- ③ The crosswise installation of the AV elements has to be identical on all four suspension rods, e.g. all upper AV mounts shall stay 90° offset. (For the suspension or support of the discharge-ends of "ROTEX" sifter types the two elements per rod shall stay parallel to each other.)
- ④ To avoid unwanted tilting motions or screen-box distortions (by standstill) we do recommend the installation of the lower AV-brackets on the level of the center of gravity "S" of the screen-box.
- ⑤ Please consult ROSTA by the selection of AV elements for staying, free oscillating gyratory sifters.

② circular oscillation

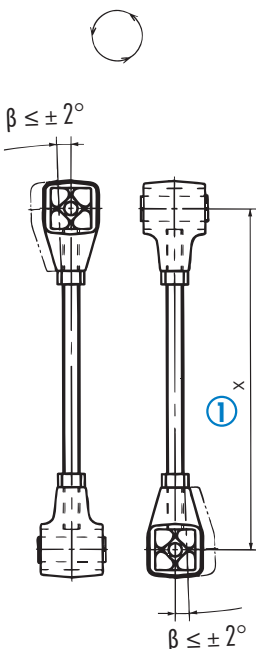

③ elliptical oscillation ("ROTEX" sifter types)

