







Selection table for Anti-vibration Mounts

Type	Description	Details	Illustration
ESL	<p>Anti-vibration Mounts for the absorption of tensile, pressure and shear load. Also ideal for wall and ceiling installations.</p> <p>8 load sizes from 200 N to 19'000 N per mount.</p> <p>Natural frequency between 3,5 – 8 Hz. Mounts are mainly used for overcritical machine installations (machine frequency > mount frequency).</p>	Page 3.8 – 3.9	
V	<p>Anti-vibration Mounts for the absorption of tensile, pressure and shear load. Also ideal for wall and ceiling installations.</p> <p>6 load sizes from 300 N to 12'000 N per mount.</p> <p>Natural frequency between 10 – 30 Hz. Mounts can be used for subcritical machine installations (machine frequency < mount frequency).</p>	Page 3.10 – 3.11	
N	<p>Mounting Feets consisting of insulating plate, glued-on top cover with built-in levelling jackscrew with spherical joint for compensation of up to 5° of floor unevenness. Insulating plate oil- and acid-proof.</p> <p>3 load sizes from 1'500 N to 20'000 N per mount.</p> <p>Natural frequency between 19 – 25 Hz.</p>	Page 3.12	
NOX	<p>Mounting Feets consisting of insulating plate, stainless steel glued-on top cover with built-in stainless levelling jackscrew with spherical joint for compensation of up to 5° of floor unevenness. Insulating plate oil- and acid-proof.</p> <p>2 load sizes from 5'000 N to 20'000 N per mount.</p> <p>Natural frequency between 19 – 22 Hz.</p>	Page 3.12	
Base plate P	<p>Accessories: For all N and NOX mounting feet light metal cast base plates are available for the compensation of possible shear loads and/or for the positioning of the installation on the floor.</p>	Page 3.12	
ISCOL	<p>Adhesive cushioning plates, self-adhesive plates for the installation of smaller machines/equipments. Plates oil- and acid-proof. (Adhesive power can be increased by moistening the plate with nitro thinner.)</p>	Page 3.13	
ISCOL U	<p>Adhesive cushioning plates, self-adhesive plates with glued-on cast cover. With central hollow in cover for the positioning of the levelling jackscrew – also with lateral stop bar for machine positioning.</p>	Page 3.13	

Further information to customized elements and installation examples as from page 3.14.

Mounting Feet

Type N
Type NOX

Accessory:
Base plate P

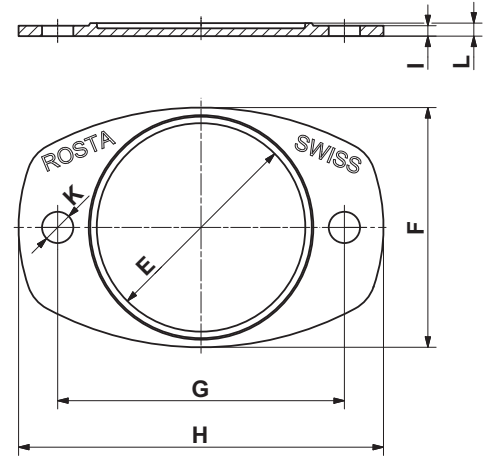
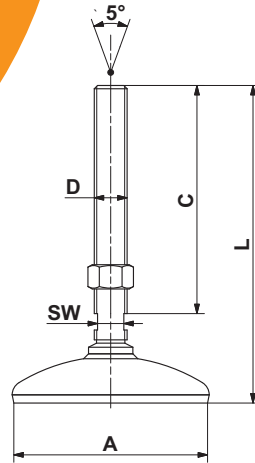

N and NOX

Art. No.	Type	Load Gmin. – Gmax. [N]	Natural frequency Gmin. – Gmax. [Hz]	øA	C	D	L	SW	Weight [kg]	Material structure (rubber pad NBR with 50 ShA)
05 058 001	N 80 M12	1'500 – 6'000	25 – 22	80	55	M12	100	10	0.3	zincd, cover blue painted
05 058 002	N 80 M16	5'000 – 12'000	22 – 19	80	136	M16	182	13	0.5	zincd, cover blue painted
05 058 102	NOX 80 M16									stainless steel 1.4301 and 1.4305
05 058 004	N 120 M20	10'000 – 20'000	22 – 19	120	139	M20	195	16	1.0	zincd, cover blue painted
05 058 103	NOX 120 M20									stainless steel 1.4301 and 1.4305

Base plate P

Art. No.	Type	Accessory to	øE	F	G	H	I	øK	L	Weight [kg]	Material structure
05 060 101	P 80	N / NOX 80	80	92	110	140	4	12	5	0.1	Light metal cast
05 060 102	P 120	N / NOX 120	120	135	170	210	5	16	7	0.3	

Options by high volume supplies

- other thread sizes and lengths
- higher load capacities
- other painting
- imprint of company logo

Applications

For the isolation of vibrations and solid-borne noise, also for machinery and apparatus requiring levelling, such as air conditioning plants, woodworking machinery, pumps, tanks, containers, transport systems, tooling machines, assembly lines and workshop equipment.

For further information to customized elements and installation examples as from page 3.14.

